

THE DEMOCRATIC SOCIALIST REPUBLIC OF SRI LANKA

**STATE MINISTRY OF SKILLS DEVELOPMENT, VOCATIONAL EDUCATION,
RESEARCH & INNOVATION**

VOCATIONAL TRAINING AUTHORITY OF SRI LANKA

**Construction of Student Sanitary Block For District
Vocational Training Centre at Elpitiya – Galle District.**

BID DOCUMENT

Chairman,
Vocational Training Authority of Sri Lanka,
“NipunathaPiyasa”,
354/2,
Elvitigala Mawatha,
Colombo 05.

Issued to :-
Tender No :-
Tender fee receipt No and Date :-
Name of Issuing officer :-

**VTA/PROC/Works/MSF/NCB/2021/01/Student Sanitary Block for DVTC
Elpitiya, Galle District.**

THE DEMOCRATIC SOCIALIST REPUBLIC OF SRI LANKA

**STATE MINISTRY OF SKILLS DEVELOPMENT, VOCATIONAL EDUCATION,
RESEARCH & INNOVATION**

VOCATIONAL TRAINING AUTHORITY OF SRI LANKA

**Construction of Student Sanitary Block For District
Vocational Training Centre at Elpitiya – Galle District**

BID DOCUMENT

Chairman,
Vocational Training Authority of Sri Lanka,
"NipunathaPiyasa",
354/2,
Elvitigala Mawatha,
Colombo 05.

Issued to :-

Tender No :-

Tender fee receipt No and Date :-

Name of Issuing officer :-

**VTA/PROC/Works/MSF/NCB/2021/01/Student Sanitary Block for DVTC
Elpitiya, Galle District.**

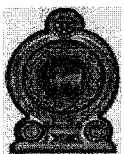

PROCUREMENT NOTICE

State Ministry of Skills Development, Vocational Education,
Research & Innovation



Vocational Training Authority of Sri Lanka

Invitation for Bids (IFB)

Renovation and Improvements of the Buildings of Vocational Training
Centers.

S. No	District	Description (Title)	Procurement No.	Engineer's Estimate (Without Contingencies & VAT) Rs.Mn	Value of Refundable Bid Security	Eligibility of Bidder CIDA (Successor to ICTAD) Grading (Buildings)	Non Refundable Document fee
1	Galle	Construction of Student Sanitary Block of DVTC-Elpitiya	VTA/PROC/Works/MSF/NCB/2021/01	3.2	Cash Rs.16,000.00 (payable to cashier of VTA) or Rs. 32,000.00 Bid Security from Bank	C - 08 or C - 07	1000.00
2	Hambantota	Construction of Student Sanitary Block of NVTI - Mirijjawila	VTA/PROC/Works/MSF/NCB/2021/03	3.2	Cash Rs.16,000.00 (payable to cashier of VTA) or Rs. 32,000.00 Bid Security from Bank	C - 08 or C - 07	1000.00
3	Monaragala	Renovation & Improvements to the workshop Buildings and Staff / Student Accommodation of VTC-Wellawayawatta	VTA/PROC/Works/MSF/NCB/2021/04	4.2	Cash Rs.21,500.00 (payable to cashier of VTA) or Rs. 43,000.00 Bid Security from Bank.	C - 08 or C - 07	1000.00
4	Batticaloa	Renovation and Improvements to the Workshop Buildings of NVTI-Vandaramoolai	VTA/PROC/Works/MSF/NCB/2021/05	4.1	Cash Rs.20,500.00 (payable to cashier of VTA) or Rs. 41,000.00 Bid Security from Bank	C - 08 or C - 07	1000.00
5	Matara	Renovation and improvements to the Main Building of VTC-Ruhunugama	VTA/PROC/Works/MSF/NCB/2021/06	7.3	Cash Rs.36,500.00 (payable to cashier of VTA) or Rs. 73,000.00 Bid Security from Bank	C - 07 or C - 06	1000.00

6	Gampaha	Construction of Student Sanitary Block of DVTC - Veyangoda	VTA/PROC/Works/MSF/NCB/2021/07	4.4	Cash Rs.22,500.00 (payable to cashier of VTA) or Rs. 45,000.00 Bid Security from Bank	C - 08 or C - 07	1000.00
7	Monaragala	Construction of Student and Staff Sanitary Block of VTC- Wellawayawatta	VTA/PROC/Works/MSF/NCB/2021/08	3.7	Cash Rs.18,500.00 (payable to cashier of VTA) or Rs. 37,000.00 Bid Security from Bank	C - 08 or C - 07	1000.00
8	Kilinochchi	Construction of Student and Staff Sanitary Block of DVTC- Kilinochchi	VTA/PROC/Works/MSF/NCB/2021/09	3.7	Cash Rs.18,500.00 (payable to cashier of VTA) or Rs. 37,000.00 Bid Security from Bank	C - 08 or C - 07	1000.00
9	Nuwaraeliya	Construction of Student and Staff Sanitary Block of DVTC- Nuwaraeliya	VTA/PROC/Works/MSF/NCB/2021/10	3.7	Cash Rs.18,500.00 (payable to cashier of VTA) or Rs. 37,000.00 Bid Security from Bank	C - 08 or C - 07	1000.00

1. The Chairman, Department Procurement Committee on behalf of the Vocational Training Authority of Sri Lanka now invites sealed bids from eligible and qualified bidders for above Buildings Renovation and Improvements of the Vocational Training Centers.
2. Bidding will be conducted through National Competitive Bidding. (NCB). Since the total Cost Estimate of this procurement is below Rs.50Mn, regional preference and CIDA grade preference shall apply as stipulated in the Public Finance Circular No. 04/2016 (ii).
3. Bidders who were not been black listed are eligible to award contract and they are informed to go through the Pre-Qualification requirements to Qualify for the contract award of the above Construction Works stated in the section 4 of each bidding document.
4. Interested eligible bidders may obtain further information from the Assistant Director (Procurement) of VTA from 20/05/2021 to 09/06/2021 at 09.00 a.m to 2.30 p.m on working days and inspect the Bidding Documents at the address given below.

Assistant Director (Procurement)
Procurement Unit
Vocational Training Authority of Sri Lanka
4th Floor, "Nipunatha Piyasa", 354/2,
Elvitigala Mawatha, Narahenpita, Colombo 05
Tel. 011-2596516, 0702576561

04

Complete set of bidding documents prepared in English Language may be purchased by the interested bidders on the submission of a written application with the copy of CIDA (Successor to ICTAD) registration by the Bidder himself or by bidders' representatives to the address given above (in item 4) and upon payment of non-refundable document fee as per the above schedule per each procurement document, from 9.00 a.m to 2.30 p.m from 20/05/2021 to 09/06/2021. The mode of payment shall be in cash in favor of Chairman, Vocational Training Authority of Sri Lanka.

6. Refundable Bid Security as per the above schedule should be by Cash Payable to Cashier of VTA or from any Commercial Bank approved by the Central Bank of Sri Lanka and should be Address to the Chairman, Vocational Training Authority.
7. A Pre-Bid Meeting will be held on 02/06/2021 at 10.30 a.m. at the Conference Room, 5th Floor at Vocational Training Authority of Sri Lanka, Colombo 05.
8. Completed bids in two copies in two separate envelopes indicating the name of the project in upper left corner as **Original & Duplicate**, and encase them in one envelope, sealed, and must be delivered by registered post or by courier service to the address given below or can be deposited in the Bid Box kept at the Procurement Unit, 4th floor of the "Nipunatha Piyasa", Vocational Training Authority on or before 10.30 a.m on 10/06/2021. Late bids will be rejected. Bids will be opened in the presence of the bidders or their representative's right after the bid closing.
9. Any bidder can bid for one or several contracts indicated in the schedule and submit separate bids. Each and every bid shall be accompanied by a Bid Security of amount described in the above table.
10. The title of the bid should be clearly mentioned in the top left corner of the bid submission envelope as specified in Procurement No. mentioned in the above Table and the Description of the Procurement.
11. Please note that guidelines for prevention of Covid-19 pandemic will be strictly followed in every step of procurement process. Therefore the following alternative Procedure can be followed / adopted due to Covid-19 Pandemic Situation.
 - i. **For the Item no.5** - Bidding documents can be purchased after paying of non-refundable fee to the Account No 119-1-001-9-3693157 Peoples Bank Narahenpita branch and submission of bank slip with written request made on company letter head via Email: bidissuecons@vtasl.gov.lk or whatsapp to Procurement officer on 0702576561. The set of bidding documents (soft copy) will be submitted through email (to the email address) mentioned in the above letter.
 - ii. **For the Item No.7**- Any Interested bidder can join the Pre-bid meeting on 02/06/2021 at 10.30 a.m. via Zoom meeting and advice to contact Assistant Director (MIS) on 0710318727 to get the Meeting ID and Password before the above date and time.
 - iii. **For the Item No.8**- Completed bids can be submitted by as protected soft copy Email: bidreceivecons@vtasl.gov.lk (Security instructions shall be given in the pre-bid meeting on 02/06/2021) before 10.30 a.m on 10/06/2021 and should be clearly mentioned specified description of the procurement mentioned in the above Table and bidder can join the bid opening via Zoom Meeting. It is advice to contact Assistant Director (MIS) on 0710318727 to get the Meeting ID and Password before the above date and time.
12. The decision of this Department Procurement Committee is final and conclusive. The Department Procurement Committee is empowered to reject any Bid at its own discretion.

Chairman,
Department Procurement Committee,
Vocational Training Authority of Sri Lanka
4th floor "Nipunatha piyasa", 354/2, Elvitigala Mawatha,
Narahenpita,, Colombo 05

51

,

Section 01

INSTRUCTIONS TO BIDDERS (ITB)

Notes:

Instruction to Bidders shall be read in conjunction with Bidding Data under Section 5 (volume 2). Matters governing the performance of the Contractor, payments under the Contract, or matters affecting the risk, rights, and obligations of the parties under the Contract are included under Section 3 – Conditions of Contract (Volume 1) and Contract Data under Section 5 (Volume 2). However, some information is reproduced in this section to facilitate the bidders to price their bids.

Instructions to Bidders will not be a part of the Contract and will cease to have effect once the Contract is signed.

Note :

Bidders are advised to refer Section 1 – Instructions to Bidders of Standard Bidding Document ICTAD Publication No. – ICTAD/SBD/03 – Second Edition – January 2007



Table of Clauses

INSTRUCTIONS TO BIDDERS

<p>A. General</p> <ol style="list-style-type: none"> 1. Scope of Bid 2. Source of Funds 3. Ethics, Fraud and Corruption 4. Eligibility and Qualification of the Bidder 5. One Bid per Bidder 6. Cost of Bidding 7. Site Visit 	<p>D. Submission of Bids</p> <ol style="list-style-type: none"> 19. Sealing and Marking of Bids 20. Deadline for submission of Bids 21. Late Bids
<p>B. Bidding Documents</p> <ol style="list-style-type: none"> 8. Content of Bidding Documents 9. Clarification of Bidding Documents 10. Amendment of Bidding Documents 	<p>E. Bid Opening and Evaluation</p> <ol style="list-style-type: none"> 22. Bid Opening 23. Process to be Confidential 24. Clarification of Bids 25. Examination of Bids and Determination of Responsiveness 26. Correction of Errors 27. Evaluation and Comparison of Bids
<p>C. Preparation of Bids</p> <ol style="list-style-type: none"> 11. Language of Bid 12. Documents Comprising the Bid 13. Bid Prices 14. Currency of Bid and Payment 15. Period of validity of Bids 16. Bid Security and Bid Securing Declaration 17. Pre-Bid Meeting 18. Format and Signing of Bid 	<p>F. Award of contract</p> <ol style="list-style-type: none"> 28. Award Criteria 29. Employer's Right to Accept any Bid and to Reject any or all Bids 30. Award and Signing of Agreement 31. Performance Security 32. Advance Payment and Security 33. Adjudicator



Instructions to Bidders

A. General

1. Scope of Bid

- **Employer**, as named in the **Schedule**, invites bids for the construction of Works as summarized in the **Schedule**;
- Successful bidder will be expected to complete the **Works** within the **Intended Completion Date** stated in the Schedule;
- **Intended Completion Date** shall be calculated from the **Start Date**.

2. Source of funds

Works will be financed by the source given in the **Schedule**.

3. Ethics, Fraud and Corruption

The attention of the bidders is drawn to the following guidelines of the Procurement Guidelines published by National Procurement Agency:

- Parties associated with procurement actions, namely, suppliers/contractors and officials shall ensure that they maintain strict confidentiality throughout the process;
- Officials shall refrain from receiving any personal gain from any Procurement Action. No gifts or inducement shall be accepted. Suppliers/contractors are liable to be disqualified from the bidding process if found offering any gift or inducement which may have an effect of influencing a decision or impairing the objectivity of an official.

The attention of the bidders is also drawn to the Sub-Clause 11.1 of the Conditions of Contract (Section 3) which shall apply to any bidder.

4. Eligibility and Qualification of the Bidder

- The bidder shall not be a blacklisted contractor at the time of bidding and at the time of award of contract.
- For domestic bidders, to qualify for the contract award the successful bidder should have been registered and hold a valid registration from the deadline for submission of bids until the expiry of the original validity of the bid, with the Institute for CIDA-Construction Industry Development Authority (successor to ICTAD), under the grade and specialty given in the Invitation for Bids/Section 4 – Qualification Information;
- All bidders shall provide, the information requested in the Section 4 - Form of Bid and Qualification Information.



- To qualify for award of the **Contract**, bidders shall meet the minimum qualifying criteria if given in Section 4- Form of Bid and Qualification Information.

All bidders shall meet (any other) requirement given in the **Schedule**.

5. One Bid per Bidder A bidder shall submit only one bid.

6. Cost of Bidding

- Bidder shall bear all costs associated with the preparation and submission of its bid;
- Employer will in no case be responsible or liable for those costs, regardless of the conduct or outcome of the bidding process.

7. Site Visit

The bidder, at the bidder's own responsibility and risk is encouraged:

- to visit and examine the Site, and its surroundings where the Works are to be executed;
- to obtain all information that may be necessary for preparing the bid and entering into a **Contract** for construction of the **Works**;
- Costs of visiting the **Site** shall be at the bidder's own expense.

B. Bidding Documents

8. Content of Bidding Documents

Bidding documents consists of two volumes stated below and shall be read in conjunction with any addenda issued in accordance with Clause 10:

Volume 1

- Section 1 – Instructions to Bidders
- Section 2 – Standard Forms (Contract)
- Section 3 – Conditions of Contract

Volume 2

- Invitation for Bids
- Section 4 – Form of Bid and Qualification Information
- Section 5 – Schedule
- Section 6 – Specifications
- Section 7 – Bills of Quantities
- Section 8 – Drawings
- Section 9 - Standard Forms (Bid)

9. Clarification of Bidding Documents

- A bidder requiring any clarification of the Bidding Documents shall contact the **Employer** in writing or facsimile at the **Employer's** address indicated in the Invitation for Bids;



- **Employer** will respond in writing to any such request for clarification received no later than seven (7) days prior to the deadline for submission of bids;
- Copies of Employer's response will be forwarded to all purchasers of the bidding documents, including a description of the inquiry but without identifying its source.

10. Amendment of Bidding Documents

- At any time prior to the deadline for submission of bids, the **Employer** may amend the bidding documents by issuing addenda;
- Any addendum thus issued shall be part of the bidding documents;
- Any addendum shall be communicated in writing or by facsimile to all purchasers of the bidding documents.

C. Preparation of Bids

11. Language of Bid

The bid as well as all correspondence and documents relating to the bid exchanged by the bidder and the **Employer**, shall be written in English language.

12. Documents Comprising the Bid

The bid submitted by the bidder shall comprise the following:

- A. Enclosed in the envelope marked as "Original"
 - a. Duly filled and signed Form of Bid and Qualification Information (in the format indicated in Section 4);
 - b. Bid security or Bid-securing Declaration as specified
 - c. Section 5 – Schedule;
 - d. Section 6 – Specifications;
 - e. Section 7 – Priced Bills of Quantities;
 - f. Section 8 – Drawings;
 - g. Any other information required to be completed and submitted by bidders as specified in the **Schedule**.
- B. Enclosed in the envelope marked as "Copy"
 - a. Duly filled and signed Form of Bid and Qualification Information (in the format indicated in Section 4);
 - b. Section 7 – Priced Bills of Quantities.

13. Bid Prices

- The **Contract** shall be for the whole **Works**, summarized in the **schedule**, and based on the priced Bills of Quantities;
- The bidder shall fill-in rates and prices for all items of the **Works** described in the Bills of Quantities;
- Items for which no rate or price is entered by the bidder will not be paid for by the **Employer** when executed and shall be deemed covered by the other rates and prices in the Bills of Quantities;



- All duties, taxes, and other levies payable by the **Contractor** under the **Contract**, or for any other cause, as of the date **14 Days** prior to the deadline for submission of bids, shall be included in the rates, prices, and total Bid price submitted by the bidder;
- VAT shall not be included in the rates or prices but shall be shown separately at the space provided in the BOQ;
- Prices shall be adjusted for fluctuations in the cost of inputs only if provided for in the **Schedule**;
- If so provided, the amounts certified in each payment certificate, after deducting for Advance Payment, shall be adjusted in accordance with Sub-Clause 10.10 of Conditions of Contract and by using either Option A or option B stated in the **Schedule**.

14. Currency of Bid and Payment

Prices shall be quoted by the bidder entirely in Sri Lanka Rupees.

15. Period of Validity of Bids

- Bids shall remain valid for the period stipulated in the Invitation for Bids after the date of bid submission specified in Clause 20;
- A bid valid for a shorter period shall be rejected by the **Employer**;
- In exceptional circumstances, prior to expiry of the period of validity of bids, the **Employer** may request that the bidders extend the period of validity for a specified additional period;
- A bidder may refuse the request;
- A bidder agreeing to the request will not be required or permitted to modify its bid, but will be required to extend the validity of its bid security for the period of the extension and in compliance with Clause 16 in all response.

16. Bid Security and Bid-Securing Declaration

- The bidder shall furnish, as part of its bid, a bid security **or** a bid securing declaration as specified in the **Schedule** in the format given in the section 9.
- The Bid Security shall be in the **amount specified in the Schedule and shall be valid until the date specified in the Schedule**, from an agency acceptable to the Employer.
- Any Bid not accompanied by a substantially responsive bid security or bid securing declaration in accordance with this clause shall be rejected by the Employer.



- The Bid security or the bid securing declaration of unsuccessful bidders shall be returned promptly upon the successful bidder furnishing the performance security.
- The bid security may be forfeited or the bid securing declaration executed:
 - a. if a bidder withdraws its bid during the period of bid validity specified by the bidder on the Form of Bid; or
 - b. if the bidder does not accept the correction of its bid price pursuant to ITB sub Clause 26;
 - c. if the successful bidder fails within the specified time to:
 - i. sign the Contract; or
 - ii. furnish the required performance security.

17. Pre-Bid Meeting The bidders designated representative is invited to attend a pre-bid meeting which, if convened and informed to the bidders, will take place at the venue and time stipulated.

18. Format and Signing of Bid

- The bidder shall prepare one original of the documents comprising the bid as described in Clause 12 and clearly marked "ORIGINAL";
- In addition, the bidder shall submit one copy of the bid, clearly marked as "COPY"
- In the event of discrepancy between them, the original shall prevail;
- The original and the copy of the bid shall be typed or written in indelible ink and shall be signed by a person or persons duly authorized to sign on behalf of the bidder;
- The bid shall contain no alterations or additions, except those to comply with instructions issued by the **Employer**, or as necessary to correct errors made by the bidder, in which case such corrections shall be initialed by the person or persons signing the bid.

D. Submission of Bids

19. Sealing and Marking of Bids

- The bidder shall seal the original and the copy of the bid in two inner separate envelopes and one outer envelope, duly marking the inner envelopes as "ORIGINAL" and "COPY";
- The inner and outer envelopes shall:
 - a) be addressed to the **Employer** at the address provided in the Invitation for Bids;



04

- b) bear the name and identification number of the **Contract** in accordance with Clause 1; and
 - c) provide a warning not to open before the specified time and date for bid opening as defined in the Clause 22.
- In addition to the identification required above, the inner envelopes shall indicate the name and address of the bidder to enable the bid to be returned unopened in case it is declared late.

20. Deadline for Submission of Bids

Bids shall be delivered to the **Employer** at the address specified above no later than the time and date specified in the Invitation for Bids.

21. Late Bids

Any bid received by the **Employer** after the deadline for submission of bids will be returned unopened to the bidder.

E. Bid Opening and Evaluation

22. Bid Opening

- The **Employer** will open the bids, in the presence of the bidders' representatives who choose to attend at the time and in the place specified in the Invitation for Bids;
- The envelope marked as "Original" will be opened. If no envelope is marked as "Original" the Employer may open one or more envelopes;
- The bidders' names, the bid prices, the total amount of each bid, any discounts, and such other details as the **Employer** may consider appropriate, will be announced by the **Employer** at the opening;
- The Employer shall reseal all the opened envelopes in the presence of the bidder's representatives.
- No bid shall be rejected at bid opening except for late bids.

23. Process to Be Confidential

Information relating to the examination, clarification, evaluation, and Comparison of bids and recommendations for the award of a Contract shall not be disclosed to bidders or any other persons not officially concerned with such process until the award to the successful bidder has been announced.

24. Clarification of Bids

- To assist in the examination, evaluation, and comparison of bids, the **Employer** may, at the **Employer's** discretion, ask any bidder for clarification of the bidder's bid, including breakdowns of prices;
- The request for clarification and the response shall be in writing.



25. Examination of Bids and Determination of Responsiveness

- Prior to the detailed evaluation of bids, the **Employer** will determine whether each bid:
 - a) Meets the eligibility criteria;
 - b) has been properly signed; and
 - c) is substantially responsive to the requirements of the bidding documents.
- A substantially responsive bid is one which conforms to all the terms, conditions, and specifications of the bidding documents, without material deviation or reservation;
- A material deviation or reservation is one:
 - a) which affects in any substantial way the scope, quality, or performance or the **Works**;
 - b) which limits in any substantial way, inconsistent with the bidding documents, the **Employer's** rights or the bidder's obligations under the **Contract**; or
 - c) whose rectification would affect unfairly the competitive position of other bidders presenting substantially responsive bids.
- If a bid is not substantially responsive:
 - a) it will be rejected by the **Employer**;
 - b) and may not subsequently be made responsive by correction or withdrawal of the nonconforming deviation or reservation.

26. Correction of Errors

- Bids determined to be substantially responsive will be checked by the **Employer** for any arithmetic errors;
- Errors will be corrected by the **Employer** as follows:
 - a) where there is a discrepancy between the amounts in figures and in words, the amount in words will govern;
 - b) where there is a discrepancy between the unit rate and the line item total resulting from multiplying the unit rate by the quantity, the unit rate as quoted will govern, unless in the opinion of the Employer there is and obviously gross misplacement of the decimal point in the unit rate, in which case the line item total as quoted will govern, and the unit rate will be corrected;
 - c) if the bid price changes by the above procedure, the amount stated in the Form of Bid shall be adjusted with the concurrence



of the bidder and shall be considered as binding upon the bidder;

- d) if the bidder does not accept the corrected amount of bid, its bid shall be rejected and the bid security may be forfeited or bid-securing declaration executed in accordance with Clause 16.

27. Evaluation and Comparison of Bids

- **Employer** will evaluate and compare only the bids determined to be substantially responsive;
- In evaluating the bids, **Employer** will determine for each bid the Evaluated Bid Price by adjusting the Bid Price as follows:
 - a) making any correction for errors;
 - b) excluding the provision, if any, for contingencies;
 - c) making an appropriate adjustment for any other acceptable variations or deviations; and
 - d) making appropriate adjustments to reflect discounts offered
- The **Employer** reserves the right to accept or reject any variation or deviation.
- Examination for unbalanced bids; If the Employer determines that the bid is unbalanced and hence the bidder may fail in the performance of his obligations in some items within the quoted rates, a higher performance security as determined by the employer may be requested to mitigate such risks.

F. Award of Contract

28. Award Criteria

Subject to Clause 29, **Employer** will award the **Contract** to the bidder whose bid has been determined to be substantially responsive to the bidding documents and who has offered the lowest evaluated Bid Price, provided that such bidder has been determined to be:

- a) eligible in accordance with the provisions of Clause 3; and
- b) qualified in accordance with the provisions of Clause 4.

29. Employer's Right to Accept any Bid and to Reject any or all Bids

Employer reserves the right to:

- a) accept or reject any bid;
- b) cancel the bidding process;
- c) reject all bids, at any time prior to the award of **Contract**,

Without thereby incurring any liability to the affected bidder (s).



30. Award and Signing of Agreement

- Prior to expiration of the bid validity period, the **Employer** will notify the successful bidder that his bid has been accepted;
- **This letter** (Hereinafter and in the Conditions of Contract called the "**Letter of Acceptance**") will state the sum that the **Employer** will pay the **Contractor** in consideration of the execution, completion, and maintenance of the **Works** by the **Contractor** as prescribed by the Contract (Hereinafter and in the **Contract** called the "**Initial Contract Price**")
- The notification of award will constitute the formation of the **Contract**;
- The **Employer** shall notify the successful bidder the date, time and venue for the signing of the agreement;
- The agreement shall be signed within **14 Days** of the Letter of **Acceptance**.

31. Performance Security

Within **14 Days** after receipt of the **Letter of Acceptance**, the successful bidder shall deliver to the **Employer** a Performance Security:

- a) to the amount equivalent to 05% of Initial Contract Price; and
- b) in the form specified in the Section 02.

32. Advance Payment and Security

Employer will provide an Advance Payment equivalent to 30% of **Initial Contract Price**, within **7 Days** of the **Contractor** submitting an acceptable guarantee.

33. Adjudicator

- The Employer nominates the Construction Industry Development Authority(successor ICTAD) as the Adjudicator. If the bidder disagrees with the nomination, the bidder shall state so in the bid. In which event the **Employer** and the **Contractor** may reach agreement on the appointment of an **Adjudicator** by mutual consent within **14 Days** from the Letter of Acceptance.
- If mutual consent is not reached or resorted to as above then the **Adjudicator** shall be appointed by the Construction Industry Development Authority(successor ICTAD) at the request of either **Party**.
- If a person is appointed as the **Adjudicator** then he shall not be associated with the project directly or indirectly and he should be in a position to demonstrate impartiality and independence in his functions.



0-1

Section 02

STANDARD FORMS (CONTRACT)

- Letter of Acceptance
- Agreement
- Performance Security
- Advance Payment Security
- Retention Money Guarantee



Notes on Form of Letter of Acceptance

The Letter of Acceptance will be the basis for formation of the Contract as described in Clause 30 of the Instructions to Bidders. This Form of Letter of Acceptance should be filled in and sent to the successful bidder only after evaluation of Bids and after obtaining approval from the relevant authority.

FORM OF LETTER OF ACCEPTANCE

[Letter heading paper of the procuring entity]

..... [date]

To:
[name and address of the Contractor]

This is to notify you that your bid dated ----- *[insert date]* for the construction and remedying defects of the ----- *[name of the Contract and identification number]* for the Contract price of -----
-----*[name of currency]*-----*[amount in figures and words]* as corrected in accordance with Instructions to Bidders and/ or modified by a Memorandum of Understanding, is hereby accepted.

You are hereby instructed to proceed with the execution of the said Works in accordance with the Contract documents.

The Start Date shall be: *(fill the date as per Clause 6.1 of Conditions of Contract).*

The amount of Performance Security is : *(fill as per Clause 4.4 of Conditions of Contract).*

The Performance Security shall be submitted on or before *(fill the date as per Clause 4.4 of Conditions of Contract).*

Authorized Signature :

Name and title of Signatory :

Name of Agency :



01

FORM OF AGREEMENT

This AGREEMENT made the [day] of [month] 20..... [year], between **The Chairman, Vocational Training Authority of Srilanka** (hereinafter called and referred to as "the Employer"), of the one part, and [name and address of Contractor] (hereinafter called and referred to as "the Contractor"), of the other part:

WHEREAS the Employer desires that the Contractor execute **Proposed Construction Student Sanitary Block for District Vocational Training Center at Elpitiya, Galle District** [name and identification no of Contract] (hereinafter called and referred to as "the Works") and the Employer has accepted the Bid Sri Lankan Rupees (LKR.....) by the Contractor for the execution and completion of such Works and remedying of any defects therein.

The Employer and the Contractor agree as follows:

1. In this Agreement words and expressions shall have the same meanings as are respectively assigned to them in the Contract hereinafter referred to.
2. In consideration of the payments to be made by the Employer to the Contractor as indicated in this Agreement, the Contractor hereby covenants with the Employer to execute and complete the Works and remedy any defects therein in conformity in all respects with the provisions of the Contract.
3. The Employer hereby covenants to pay the Contractor in consideration of the execute and complete the Works and remedy any defects therein, the Contract Price or such other sum as may become payable under the provisions of the Contract at the times and in the manner prescribed by the Contract.

In Witness whereof the parties hereto have caused this Agreement to be executed the day and year aforementioned, in accordance with laws of Sri Lanka.

.....
Authorized signature of Contractor

.....
Authorized signature of Employer

COMMON SEAL

COMMON SEAL

In the presence of:
Witnesses :

1. Name and NIC No.
Signature
Address
2. Name and NIC No.
Signature
Address



FORM OF PERFORMANCE SECURITY (Unconditional)

----- [Issuing
Agency's Name, and Address of Issuing Branch or Office]

Beneficiary: ----- [Name
and Address of Employer]

Date: -----

PERFORMANCE GUARANTEE No.: -----

We have been informed that ----- [name of Contractor] (hereinafter called "the Contractor") has entered into Contract No. ----- [reference number of the contract] dated ----- with you, for the ----- [insert "construction"] of ----- [name of contract and brief description of Works] (hereinafter called "the Contract").

Furthermore, we understand that, according to the conditions of the Contract, a performance guarantee is required.

At the request of the Contractor, we ----- [name of Agency] hereby irrevocably undertake to pay you any sum or sums not exceeding in total an amount of ----- [amount in figures] (-----) [amount in words], upon receipt by us of your first demand in writing accompanied by a written statement stating that the Contractor is in breach of its obligation(s) under the Contract, without your needing to prove or to show grounds for your demand or the sum specified therein.

This guarantee shall expire, no later than the -----day of -----, 20---- [insert date, 28 days beyond the Intended Completion Date] and any demand for payment under it must be received by us at this office on or before that date.

[signature(s)]



FORM OF ADVANCE PAYMENT SECURITY

----- [Name and address of Agency, and Address of Issuing Branch or Office]

Beneficiary: ----- [Name and Address of Employer]

Date: -----

ADVANCE PAYMENT GUARANTEE No.: -----

We have been informed that ----- [name of Contractor] (hereinafter called "the Contractor") has entered into Contract No. ----- [reference number of the contract] dated ----- with you, for the ----- construction of ----- [name of contract and brief description] (hereinafter called "the Contract").

Furthermore, we understand that, according to the conditions of the Contract, an advance payment in the sum ----- [amount in figures] (-----) [amount in words] is to be made against an advance payment guarantee.

At the request of the Contractor, we ----- [name of issuing agency] hereby irrevocably undertake to pay you any sum or sums not exceeding in total an amount of ----- [amount in figures] (-----) [amount in words] upon receipt by us of your first demand in writing accompanied by a written statement stating that the Contractor is in breach of its obligation in repayment of the advance payment under the Contract.

The maximum amount of this guarantee shall be progressively reduced by the amount of the advance payment repaid by the Contractor.

This guarantee shall expire on ----- [Insert the date, 28 days beyond the expected expiration date of the Contract]

Consequently, any demand for payment under this guarantee must be received by us at this office on or before that date.

[signature(s)]



FORM OF RETENTION MONEY GUARANTEE

-----[Issuing Agency's Name,
and Address of Issuing Branch or Office]

Beneficiary: ----- [Name and Address of
Employer]

Date: -----

RETENTION MONEY GUARANTEE No.: -----

We have been informed that ----- [name of Contractor]
(hereinafter called "the Contractor") has entered into Contract No. ----- [reference number of the
contract] dated ----- with you, for the execution of ----- [name of contract and brief
description of Works] (hereinafter called "the Contract").

Furthermore, we understand that, according to the conditions of the Contract, when the works have being
taken over and the first half of the Retention Money has been certified for payment, payment of the second
half of the Retention Money may be made against a Retention Money guarantee.

At the request of the Contractor, we ----- [name of agency] hereby
irrevocably undertake to pay you any sum or sums not exceeding in total an amount of -----[amount in
figures] (-----) [amount in words] upon receipt by us of
your first demand in writing accompanied by a written statement stating that the Contractor is in breach of its
obligation under the Contract because the Contractor has not attended to the defects in accordance with the
Contract..

This guarantee shall expire, at the latest, ----- [insert 28 days after the end of the defects
liability period]. Consequently, any demand for payment under this guarantee must be received by us at this
office on or before that date.

[signature(s)]



Section 03

CONDITIONS OF CONTRACT

Conditions of Contract shall be read in conjunction with the
Section 5 –Schedule in Volume 2 , with shall take Precedence over the
Conditions of Contract

Refer the ICTAD/SDB/03
(2nd Edition-(Revised) January 2007)



Section - 04

FORM OF BID AND QUALIFICATION INFORMATION

Web File



01

FORM OF BID

Name of Contract : **Proposed Construction Student Sanitary Block at District Vocational Training Center at Elpitiya - Gall District.** *Galle District*

To : **Chairman, Vocational Training Authority of Srilanka**

Gentleman,

1. Having examined the Standard Bidding Document - Procurement of Works - Minor Contracts [ICTAD/ SBD/ 03 - Second Edition, January 2007], Schedule, Specifications, Drawings and Bills of Quantities and addenda for the execution of the above-named Works, we/I the undersigned, offer to execute and complete such Works and remedy any defect therein in conformity with the aforesaid Conditions of Contract, Schedule, Specifications, Drawings, Bill of Quantities and Addenda for the sum of Sri Lankan Rupees
.....
(LKR) or such other sums as may be ascertained in accordance with the said Conditions.
2. We/I acknowledge that the Schedule forms part of our Bid.
3. We/I undertake, if our Bid is accepted, to commence the Works as stipulated in the Schedule, and to complete the whole of the Works comprised in the Contract within the time stated in the Schedule.
4. We/I agree to abide by this bid for the period stated in the Sub-Clause 15 of Instructions to Bidders or any extended period and it shall remain binding upon us and may be accepted at any time before the expiration of that period.
5. Unless and until a formal agreement is prepared and executed this Bid, together with your written acceptance thereof, shall constitute a binding contract between us/me.
6. We/I understand that you are not bound to accept the lowest or any Bid you may receive.

Dated this day of 20..... in the capacity of duly authorized to sign

tenders for and on behalf of

(IN BLOCK CAPITALS)

Signature :

Address :

Witness :



Qualification Information

(to be completed by the bidder and submitted with the Bid. Copies of relevant certificate [certifying as a true copy] should also be attached)

	Eligibility Requirement	Bidder's Qualification
ICTAD Registration		
Registration number		
Grade	CIDA Grade C8 or C7	
Specialty	Civil Construction Work	
Expiry Date		
Blacklisted Contractors		
Have you been declared as a defaulted contractor by NPA or any other Agency?		Yes/No
IF yes provide details		
VAT Registration Number		
Construction Program		To be Submitted by the Bidder
Legal status	Public company/Private Company/Partnership/Sole proprietor	

	Eligibility Requirement		Bidder's Qualification
Qualification and experience of key staff⁸	Category, Experience and Qualifications	Required Nos.	Proposed by bidder (Name, experience and Qualifications)
	Technical: NDT with 01 year or NCT with 05 years of Post qualified Experience in Civil Construction	1	
	Managerial:		
List Other information required	<p>*Total turnover of Construction Work completed During the last 5 years 23M</p> <p>*Experience as a main construction and completion of at least one work of similar Nature of work during Last 5 Years: 3.0M</p> <p>*Bidder should be submitted Permanent Over Draft (POD) facility from the reputed commercial bank approved by the Central Bank of Srilanka, address to the Chairman, vocational training Authority of Srilanka and mention Project name and - or Audited Report minimum liquidity :Not less than 0.7M</p>		

Signature of the Bidder :



Section - 5

SCHEDULE

Note:

This section shall be read in conjunction with Section 1-Instructions to Bidders and Section 3-Conditions of Contract, and is intended to provide specific information in relation to corresponding Clauses in Sections 1 & 3. Whenever there is an ambiguity, the provisions in Section 1-Instructions to Bidders and Section 3-Conditions of Contract.



Schedule

ITB Clause	Conditions of Contract Clause	Item	Data
1.	1.1.8	Employer is :	Name : Chairman, Address: Vocational training Authority of Srilanka. No.354/2,Elwitigala Mw,Colombo 05.
	1.1.10	Engineer is :	Name : Deputy Director Address: Construction Unit, Vocational training Authority of Srilanka. No.354/2,Elwitigala Mw,Colombo 05.
1 & 13	1.1.21	Summary of Works:	The works consists of Masonry, Plastering, Painting Works, Floor, Wall Tile, Roof Works, Sanitary Fittings and Aluminium Works. <i>Plumbing work</i>
		Located at	District Vocational Training Center-Elpitiya
		Contract Name	Proposed Construction of Student Sanitary Block for Distric Vocational Training Center at Elpitiya - Galle District.
		Contract Number	VTA/PROC/Works/MSF/NCB/2021/01
1.	1.1.14	Intended Completion Date is	60 days from the starting date of the Construction
2.		Source of Funds	The source of Funds is GOSL
3.		Eligibility	The requirements is CIDA(successor ICTAD) registration for C7 or C8 category in the field of Building.
12.		Document of the Bids	Any other information - Not applicable
13.	10.10	Price Adjustment	Not applicable



- 16 Bid Security/Bid Securing Declaration Bid shall include a Bid Security :
- I. For an amount **Rs . 32,000.00**. Issued by an reputed bank recognized by the Central Bank of Sri Lanka acceptable to Employer obtained in favour of The Chairman, Vocational Training Authority using the form for bid security (unconditional guarantee) included in Section 9, Standard Forms.
 - II. OR Rs **.16,000.00** payable to cashier of Vocational training Authority of Srilanka.
 - III. Bid Security shall be Valid until 10.06.2021 to 04.11.2021 (148 days)
 - IV. The Bids shall be valid 10.06.2021 to 07.10.2021 (120 days)
- 17 Pre –Bid meeting Pre-Bid meeting will be held on **02.06.2021 10.30.a.m** at Conference Room, 5th floor, Vocational Training Authority of Sri Lanka. Any Interested bidder can join the Pre-bid meeting on **02/06/2021 at 10.30 a.m.** via Zoom meeting and advice to contact Assistant Director (MIS) on **0710318727** to get the Meeting ID and Password before the above date and time.
- 18 Deadline for Submission of Bids Completed bids in two copies in two separate envelops indicating the name of the project in upper left corner as **Original & Duplicate**, and encase them in one envelop, sealed, and must be delivered by registered post/Currier to the **Chairman, Vocational training Authority of Srilanka. No.354/2, Elwitigala Mw, Colombo 05**
- Or can be submitted as protected soft copy by Email: **bidreceivecons@vtasl.gov.lk** (security instructions shall be given in the pre bid meeting on 02/06/2021) clearly mentioning the contract name in the clause 1.1.21.



			<p>Or can be deposited in the Bid Box kept at the Procurement Unit, 4th floor of the "Nipunatha Piyasa", Vocational Training Authority on or before 10.30 a.m on 10/06/2021.</p> <p>Late bids will be rejected.</p>
22		Bid Opening	<p>Bids will be opened on 10.30 a.m on 10/06/2021 in the presence of the bidders or their representative's right after the bid closing.</p> <p>Bidder can join the bid opening via Zoom Meeting.</p> <p>It is advice to contact Assistant Director (MIS) on 0710318727 to get the Meeting ID and Password before the above date and time.</p>
31	4.4	Performance Security	<p>Amount of Performance Security required is 5% of The Initial Contract Price.</p> <p>The form acceptable is :</p> <p>Unconditional on demand Guarantee from a reputed Bank recognized by the Central Bank of Sri Lanka Acceptable to the Employer.</p>
	6.4	Late Completion	<p>The amount to be paid is 0.05% of the Initial Contract Price per Day, subjected to maximum of 10% of Initial Contract Price.</p>
	8.1	Notification of Defects	<p>The period of Defect Notification is 365 Days from taking over</p>
	10.3	Retention	<p>The amount of retention is 10% of certified work done.</p> <p>The maximum amount of retention is 5% of Initial Contract Price.</p>



10.12	Advance Payment		Upon the payment of the advance payment in full the Employer shall return the original of the advance payment guarantee to the Contractor.
	13.1(c)	Insurance, third Party	Minimum amount for third party insurance is Rupees 500,000.00 per occurrence without limitation to the number of occurrence per year
	13.1	Insurance for Contractor's Personnel	Minimum amount for Insurance for Contractor's Personnel is Rupees 500,000.00 per occurrence without limitation to the number of occurrence per year
33	1.1.11	Adjudicator	Fees and types of reimbursable expenses to be paid to the Adjudicator shall be on case to case basis
	14.0	Resolution of Disputes.	and shall be shared by the Contractor and the Employer



Section – 06

SPECIFICATIONS

Web File



GENERAL SPECIFICATIONS

The General Specifications are the Specifications given in the following documents issued by the **CIDA (Construction Industry Development Authority) successor ICTAD, 'Savsiripaya', Wijerama Mawatha, Colombo 7.**

<u>Publication No</u>	<u>Description</u>
SCA/3/1	Specifications Irrigation & Land Drainage, Sri Lanka, Second Edition (Revised) – November 1999.
SCA/3/2	Specifications Water Supply Sewerage & Storm Water Drainage, Sri Lanka, Second Edition (Revised) – April 2002.
SCA/4	Specifications for Building works Vol. I, Sri Lanka, Third Edition (Revised) – July 2004.
SCA/4/II	Specifications for Building works Vol.II, Sri Lanka, Second Edition (Revised) – October 2001.
SCA/5	Standard Specifications for Construction and Maintenance of Road and Bridges, Sri Lanka, Second Edition (Revised) – June 2009.

Any other Standard Specifications approved by the Government of Sri Lanka



Section – 07

BILLS OF QUANTITIES

Notes: In preparation of the bidding document the users are advised to:

- (1) Include appropriate Preliminary Bill items as Bill No. 01 in accordance with ICTAD Publication No. ICTAD/ID/04.*
- (2) Allow provision for the bidders to include the VAT Component separately and instruct them not to carry the VAT component to the Form of Bid.*
- (3) Advise the bidders that any discount offered will not be considered for Provisional Sum Items.*



Proposed Construction of Students Sanitary Block for at DVTC Elpitiya Galle District					
Method of Payment-Measure and Pay Basis					
1	Preliminaries	Unit	Qty	Rate	
A.1	Allow for submission of performance bond. Actual cost for obtaining bonds and guarantees will be reimbursed to the contractor on submission of documentary proof subject to the maximum quoted for this item.	Item	Allow	Sum	
A.2	Allow for submission of advance payment guarantee. Actual cost for obtaining bonds and guarantees will be reimbursed to the contractor on submission of documentary proof subject to the maximum quoted for this item.	Item	Allow	Sum	
A.3	Provide lump sum for all necessary requirements for protective nets, screens and to prevent dengue etc directed by the Engineer.	Lump	Sum	Sum	
A.4	provide lump sum to cover the Insurance against accidents and injury to contractor's personnel as per the Contract.	Item	Allow	Sum	
A.5	Provide for providing temporary building for contractor's staff accommodation including sanitary facilities.	Item	Allow	Sum	
A.6	Provide for construction Technical Manegment Services officer with NCT (Civil) with 5 Years Experience (@ Rs. Per month)	Item	Allow	Sum	
A.7	Provide for all necessary safety measure to workmen at site confirming to latest industrial safety regulations.	Item	Allow	Sum	
A.8	Provide for providing water for use of the works.	Item	Allow	Sum	
A.9	Provide for supplying electricity for use of the works.	Item	Allow	Sum	
A.10	Provide for clearing of site on completion and removal of all rubbish and debris, leaving all in good condition.	Item	Allow	Sum	
	Total Carried to Grand Summary				

Proposed Construction of Student Sanitary Block at DVTC Elpitiya - Galle District.

Method of Payment-Measure and Pay Basis

Bii No-02					
Construction Work					
BOQ No	Description	Unit	Qty		
	Note				
	Bidders are advice to inspect the site before pricing thr BOQ and it is the responsibility of the bidders to carry out the renovation work in oder to satisfy the client with in the said amount				
1	Excavation & Earth work				
1.1	Removing top soil and Clearing site vegetation, removing bushes, shrubs & top soil to a depth not exceeding 6" and removing all debris away from site with transport.	Sqr	5.00		
1.2	Manual Excavation for wall foundations in any material (except rock requiring blasting) up to 5'-0" depth, part return fill in and ram and surplus deposited within site as directed.	Cube	2.20		
1.3	Approved hard Earth Supplying, spreading , leveling watering and manual compaction, using standard machine rammer or equivalent and filling in 150 mm thick layers.(floor and back filling)	Cube	3.50		
	Total Carried to Summary Construction work				
2	Concrete				
2.1	Cement concrete 1:3:6 (1") in foundation and under rubble foundation (lean concrete of 2" thickness) with curing.	Sqr	2.00		
2.2	Plinth Beam size 9" x9" deep in Grade 20 concrete, reinforced with 4 nos of 12mm dia. tor steel bars and 6mm mild steel stirrups @ 6" c/c As per the including formwork with curing continuously for 7 days.	L.ft	123.00		
2.3	3" thick floor concrete in 1:2:3(3/4) including leveling and floor expansion joints filled with cement and sand .	Sqr	2.80		
2.4	R.C.C lintels size 4" x 8" deep in Grade 25 concrete, reinforced with 4 nos of 10mm dia. tor steel bars and 6mm mild steel stirrups @ 6" c/c including necessary formwork in ground floor with curing continuously for 7 days.(Max length of a lintol 6'-0")	L.ft	107.00		

2.5	Cement concrete drains of internal size 6" wide and depth varies from 6" - 9" ,consist of 3" thick base and side walls in 1:2:4 (3/4") including 1/2" thick 1:3 rendering with 3" thick & 2'-6" width concrete ramp, including necessary formwork with curing continuously for 7 days.	L.ft	73.50		
Total Carried to Summary of Construction work					
3 Flooring					
3.1	Gauge 1000 polythene damp proof membrane with 6" laps laid under floors.	Sqr	2.00		
Total carried to grand summary construction work					
4 Rubble work					
4.1	Random rubble (6"x9") masonry in cement sand mortar 1:5 in wall foundation.	Cube	1.80		
Total carried to grand summary construction work					
5 Block work					
5.1	Construction of 4" thick solid block walls in 1:5 cement sand mortar with high quality cement blocks with SLS certification.	Sqr	8.00		
Total carried to grand summary construction work					
6 Plastering					
	A chicken mesh to be used prior to plastering where at concrete masonry work joints to prevent cracks.				
6.1	Plastering of 5/8" thick Internal and external walls, in cement and sand 1:5 including reveals .	Sqr	17.00		
Total carried to grand summary construction work					
7 Floor and wall Finishes					
7.1	Supplying and fixing high quality 12"x12" Homogeneous ceramic mat finished floor tile laying on 1:3 cement sand bedding and pointed with tile grout to match the tile. Rate shall be included for grouting and finishing , cleaning the surface, necessary tile bedding cutting tiles etc. (prime cost of the floor tile Rs.200.00)	Sqr	2.80		
7.2	Supplying and fixing glazed ceramic wall tiling up to 5' ft. Height from the floor level using the high quality 12"x8" or 12"x16" wall tiles laying on 1:3 cement sand layer and pointed with tile grout to match the tile.Rate shall be included for grouting and finishing , cleaning the surface, necessary tile bedding cutting tiles etc.(prime cost tile Rs.300.00)	Sqr	7.00		

7.3	Construction of 3' 0" wide pavement with excavation compaction leveling and laying 4" thick 1:2:4 (3/4") concrete.	L.ft.	100.50		
Total carried to grand summary construction work					
8 Painting					
8.1	Painting walls with one coats of wall primer including preparing surface for interior application before application of emulsion paint.	Sqr	16.00		
8.2	Painting walls with two coats of weathershield paint including preparing surface.	Sqr	15.00		
Total carried to grand summary construction work					
9 Aluminium Work					
9.1	Aluminum Single Sash Door (Aluminium Composite Panel & Glazed).(frame 1.5mm thick 100mm deep & sash 1.6mm thick ,100mm deep) Bronze anodized single sash butt hinged openable door with middle rail , panelling with 4mm thick aluminium composite panel neoprene and woold beading, gaskets, pop rivets, threaded bar with nut and approved quality lock, butt hinges, door handle with cap nut,locking divises & other necessary accessories As per the members , sizes and details given in drawing	Sq.ft.	126.50		
9.2	Supply & fixing 2'-0" X 2'-6" 1.2mm thick 40mm x 35mm depth bronze anodized top hung fanlight sash with 41mm Aluminum frame for single sash with top louver panel (3 Nrs.)	Sq.ft.	18.00		
9.3	Supplying and fixing approved quality toilet partition work with necessary & fittings for divid urinals (besco, Kubik or equivalent).	Sq.ft.	15.00		
Total carried to grand summary construction work					
10 Roof covering and roof plumbing					
10.1	Supplying and fixing 100mm x 50mm x 6mm thick H-iron portal frame & fixed top of gable wall .Rate shall include fabricating, transporting, hoisting, fixing in position and applying two coats of anti corrosive paint and two coat of enamel paint.	L.ft.	60.00		
10.2	Supplying and fixing high tensile galvanized steel 100x50x20x2mm thick "C" channel purlings (Tensile strength 450 N/mm ²) Each purling connected with portal frame roof truss with 75mm x 75mm x 6mm L-iron cleats in nuts and bolts with necessary accessories. Rate shall include fabricating, transporting, hoisting, fixing in position and applying two coats of anti corrosive paint and two coat of enamel paint.	L.ft.	180.00		

10.3	Supplying and fixing colour bonded zinc alum profile roofing sheet (minimum base metal thickness of 0.4mm and 150mg/m ² coating) and minimum thickness of 0.47mm, laid on purlings with joints to be properly connected with self fastener screws and complete to working order. Rate shall include fixing ridge capping.	Sqr	6.00		
10.4	Supply and fixing proprietary coated zinc alum gutter (minimum base metal thickness of sheet 0.4mm and minimum total thickness 0.47mm) Girth 470 complete with stop end plates, running joints, pop rivot etc. All joints to be properly connected with an adequate laps not less than 150mm length and with sealant to ensure water tightness along the entire length of the gutter and including gutter brackets at 450mm centers with an adequate slope as directed and including application of two coats of each anticorrosive paint and enamel paint to all steel surfaces to match the gutter fix in position.	L.ft.	70.00		
10.5	Supply and fixing 0.47mm zinc alum valance/barge board with 20mmx5mmx12" long flat iron brackets 2' 0" centers and complete to working order. Rate shall include applying two coats of anti corrosive paint and one coat of enamel paint to all steel surfaces.	L.ft.	100.00		
10.6	Supply and fixing proprietary coated zinc alum down pipe size 100x100 compatible for girth 470mm gutter complete with necessary nozzle, offset, 30' degree bend down pipe, shoe, down pipe bracket, ect. (minimum base metal thickness of sheet 0.4mm and minimum total thickness 0.47mm) All joints to be properly connected and with sealant to ensure water tightness along the entire length. Down pipe brackets fix to 1.0 m c/c.	L.ft.	90.00		
Total carried to grand summary construction work					
11 Sanitary fittings					
	All unplasticized polyvinyl chloride (uPVC) pipes used in the plumbing installation must conform in every respect to the requirements of the SLS 147 of 1989 & 1972 or BS 4514.				
	All fittings and specials used in the plumbing installation shall be suitable in all respects to the pipe line to which fittings and specials are fixed.				
Rates for plumbing work shall include for:-					
	(a) Complying with the relevant Sri Lanka, British or any other standard as given under the specifications and with the regulations of the relevant authorities.				
	(b) Rate shall include Cutting and waste of pipes etc. and joining pipes.				
	(c) Rate shall include All specials such as elbows, bends, tees, junctions, plugs, reducers and similar pipe fittings.				
	(d) Rate shall include All pipe and fittings Connecting to sanitary fixtures and appliances.				

	(e) Rate shall include Necessary screws, nails sockets, connection back nuts standard pipe fixing or supporting clips, saddles, brackets, holder bats, straps etc.				
	(f) Testing and disinfections after completion.				
	(g) Excavation, backfilling, disposal for surplus spoil				
	Rates for Drainage Work shall include for :-				
	(a) Laving of pipes to falls.				
	(b) Excavation, backfilling, disposal of surplus spoil				
	(c) All pipe specials such as bends, junctions, elbows, tees etc. Unless separately shown in the BOQ.				
	(d) Connection to sides of manholes etc.				
	(e) Providing sleeves etc., when pipes pass through walls, foundations etc.				
	(f) Testing installation as specified				
	(g) Protecting the works.				
	Rates for Sanitary fittings shall include for:-				
	(a) Fittings such as taps, waste water outlet, internal overflows etc. and supporting brackets, incidental materials for fixing.				
	(b) Assembling, jointing together fixing components parts, and jointing to pipes including necessary coupling and for leaving perfectly clean and in perfect working order as on completion.				
	(c) Jointing and connection pipes to sanitary fittings.				
	(d) Testing and commissioning of the installation.				
	(e) Making good the work disturbed.				
	(f) Submitting samples for the approval of the client.				
	(g) Protecting the works				
	Sample to be approved by the client.				
11.1	Supply and fixing white vitreous china floor standing wash basin and pedestal Roccel Dune brand or equivalent with overflow hole and single tap hole in center of complete to working order inclusive of the 1 1/4" chromium plated waste outlet and 1 1/4" chromium plated siphon cleanable bottle trap. (prime cost of the wash basin Rs.15,000.00)	Nr	4.00		
11.2	Supply and fix white ceramic Squating pan with rest, wash down flushing with 6/3 liters dual flushing having horizontal outlet with Universal drain bend and two lateral holes for bottom water connection, cistern with water inlet from rear. Complete to working order inclusive of universal bend.(prime cost Rs.10,500.00)	Nr	2.00		

11.3	Supply and fixing white vitreous china floor standing close coupled semi back to wall water closet suite with wash down flushing with 6/3 liters dual flushing has horizontal outlet with vario drain bend and two lateral holes for bottom water connection, P trap, cistern with water inlet from rear of Roccel Dune brand or equivalent and complete to working order. (prime cost for commode and cistern-Rs. 33,000.00)	Nr	2.00		
11.4	Supply and fixing ceramic urinal (American Standard TF -412 or equivalent) with flush valve (American standard A-500-N or equivalent) of approved quality complete to working order (prime cost Rs 16,092.00 with VAT, and flush valve Rs.15,714.00 with VAT).	Nr	3.00		
11.5	Supply and fixing high quality chromium plated pillar tap (Rocell SDQA 053 or equivalent)(cold water) for wash basin complete to working order.(prime cost for pillar tap - Rs. 3,800.00)	Nr	4.00		
11.6	Supply and fixing high quality chromium plated 1/2" dia Angle tap (Rocell A279 or equivalent) complete to working order.(prime cost for angle tap - Rs. 1,400.00)	Nr	8.00		
11.7	Supply and fixing high quality chromium plated bidet spray (Rocell AAOI CCB or equivalent) complete to working order.(prime cost for bidet spray - Rs. 1,500.00)	Nr	4.00		
11.8	Supply and fixing high quality brass chromium plated 1/2" dia 24" long flexible horse complete to working order.(prime cost for flexible horse - Rs. 1,200.00)	Nr	4.00		
11.9	Supply and fixing 800mmx500mm mirror (Rocell or equivalent) 5mm thick double coated with pencil edge back strecher. (prime cost for mirror - Rs. 9,900.00)	Nr	2.00		
11.11	Supplying and fixing gully box with chromium plated cover with all necessary accessories.	Nr.	2.00		
11.12	Supply and fixing 1/2" dia plastic flexible hose - 18" length.	Nr.	2.00		
11.14	Supplying & fixing pipes P.V.C, 1/2" dia. (Type 1000) including specials.	L.ft.	100.00		
11.15	Supplying & fixing pipes P.V.C, 3/4"dia. (Type 1000) including specials.	L.ft.	150.00		
11.16	Supplying & fixing pipes P.V.C, 1"dia. (Type 1000) including specials.	L.ft.	100.00		

11.17	Supplying and fixing 2" dia. P.V.C waste pipe (type 600) (with specials)	L.ft.	21.00		
11.18	Supplying and laying 4" dia.P.V.C. sewer pipes (type 600) Including cement concrete surrounding 1:3:6: (1").	L.ft.	60.00		
11.19	Supplying and laying 1 1/2" dia. P.V.C waste pipe (type 1000) (with specials)	L.ft.	40.00		
11.20	Supplying and laying 1 1/4" dia. P.V.C waste pipe (type 1000) (with specials)	L.ft.	40.00		
11.21	Supplying & fixing valve P.V.C, 3/4"dia. (Type 1000) .	Nos	4.00		
11.22	Supplying & fixing valve P.V.C, 1"dia. (Type 1000) .	Nos	1.00		
11.23	Supplying & fixing P.V.C, Elbow 4"dia. (Type 1000) .	Nos	8.00		
11.24	Supplying and fixing bends with cleaning eye uPVC 4".	Nr.	4.00		
11.25	Construction of waste water brick manhole internal size of 1'-6" x 1'-0" & depth up to 1'-6", consist of 3" thick Grade 15 concrete base and 4 1/2" thick brick masonry side walls in 1:3 cement sand mix , 1/2" thick cement rendering in 1:2 to internal & external exposed surfaces of walls finished smooth with neat cement floating, with 2" thick Grade 20 RCC cover slab with 6mm dia. M.S. rods @ 4" c/c both ways. Rate to include for excavation, necessary formwork ,3" thick RCC lid reinforced with Y10 bars at 6" intervals bothways ,and 2 lifting devices with Y12 bars.	Nr.	2.00		
11.26	Construction of Sewer brick manhole internal size of 1'-6" x 1'-0" & depth up to 2'-0", consist of 3" thick Grade 15 concrete base and 4 1/2" thick brick masonry side walls in 1:3 cement sand mix , 1/2" thick cement rendering in 1:2 to internal & external exposed surfaces of walls finished smooth with neat cement floating, with 2" thick Grade 20 RCC cover slab with 6mm dia. M.S. rods @ 4" c/c both ways. Rate to include for excavation, necessary formwork ,3" thick RCC lid reinforced with Y10 bars at 6" intervals bothways ,and 2 lifting devices with Y12 bars.	Nr.	7.00		
11.27	Supplying and fixing 3'-0" internal dia.x 4'-0" depth & 3" thick walls, Pre-cast soakage pit for sewer, with perporated holes including necessary excavation including working space and 6" thick gravel packing surrounding the tank. Rate shall include necessary pipe and fittings and hire charges of boom truck for placing.	Nr	3.00		

11.28	Supplying and fixing 4'-0" dia.x 8'-0" Pre-cast Septic tank including excavation depth not exceeding 8'-0" and placed on bedding from 1' 0" below bottom of the septic tank and fill up to 2' 0" height surrounding the tank. Rate shall include necessary pipe and fittings and hire charges of boom truck for placing.	Nr	2.00		
Total carried to grand summary construction work					
12	Electrical Installation				
	Note				
	1. The contractor must agree to complete the works within the time stated in the Form of Tender.				
	2. The contractor shall make arrangement to obtain at his own expense a supply of electricity required for the work.				
	3. The contractor must complete electrical works as per detail drawings and layout.				
	4. All electrical cables are SLS 733 BS.6004 quality.				
	5. Rate shall be include necessary wires, conduits, casing, clips, nails and complete working order.				
12.1	Supplying and fixing pendent mounted type 6W LED approved quality light fittings wired with 1/1.13 PVC wire and 7/0.67 PVC earth wire with all necessary conduits, clips, junction boxes and switch etc. Lamp fitting must be one year warranty and before fixing sample must be supply to client to approval. (prime cost of the pendent light Rs.800.00)	Nr	13.00		
12.2	Supply and fix DB as per following details.	Nr	1.00		
	Box size :- 8 way DB box				
	Fixing Electrical Items :-				
	1 No,230V/40A/30mA/ RCCB				
	1 No,230V/40A/ isolater				
	3No,10A/230V/ MCB				
12.3	Supply and wiring 6mm 7/1.04mm PVC/PVC/Cu twin flat main wire complete to working order including conduit/casing from main panel to sub panel. Rate should be inclusive of any accories requird.	L.ft.	115.00		
Total carried to grand summary construction work					

**Proposed Construction of Students Sanitary Block at DVTC Elpitiya-
Galle District
Summary - Construction Work**

BOQ NO	Description	
1	Excavation	
2	Concrete	
3	Flooring	
4	Rubble Work	
5	Block Work	
6	Plastering	
7	Floor Finishes	
8	Painting Work	
9	Aluminium Work	
10	Roof Covering and Roof Plumbing	
11	Sanitary Fittings	
12	Electrical Installation	
	Carried to Grand Summary	

Proposed Construction of Students Sanitary Block at DVTC Elpitiya Galle District

Grand Summary

Bill No 01	
Preliminaries	=
Bill No 02	
Construction Work	=
Sub Total 1	
Allow discounts/additions (If Any)	=
Sub Total 2 (Carried to from of bid)	=
VAT 8%	=
Total with VAT	=

Signature of Bidder:

Name & address of the Bidder:-

Witness 01

Name & address of the witness-

Name & address of the witness-

Witness 02

Signature of the witness -

Name & address of the witness-

Section – 08

DRAWINGS

Web File



0-

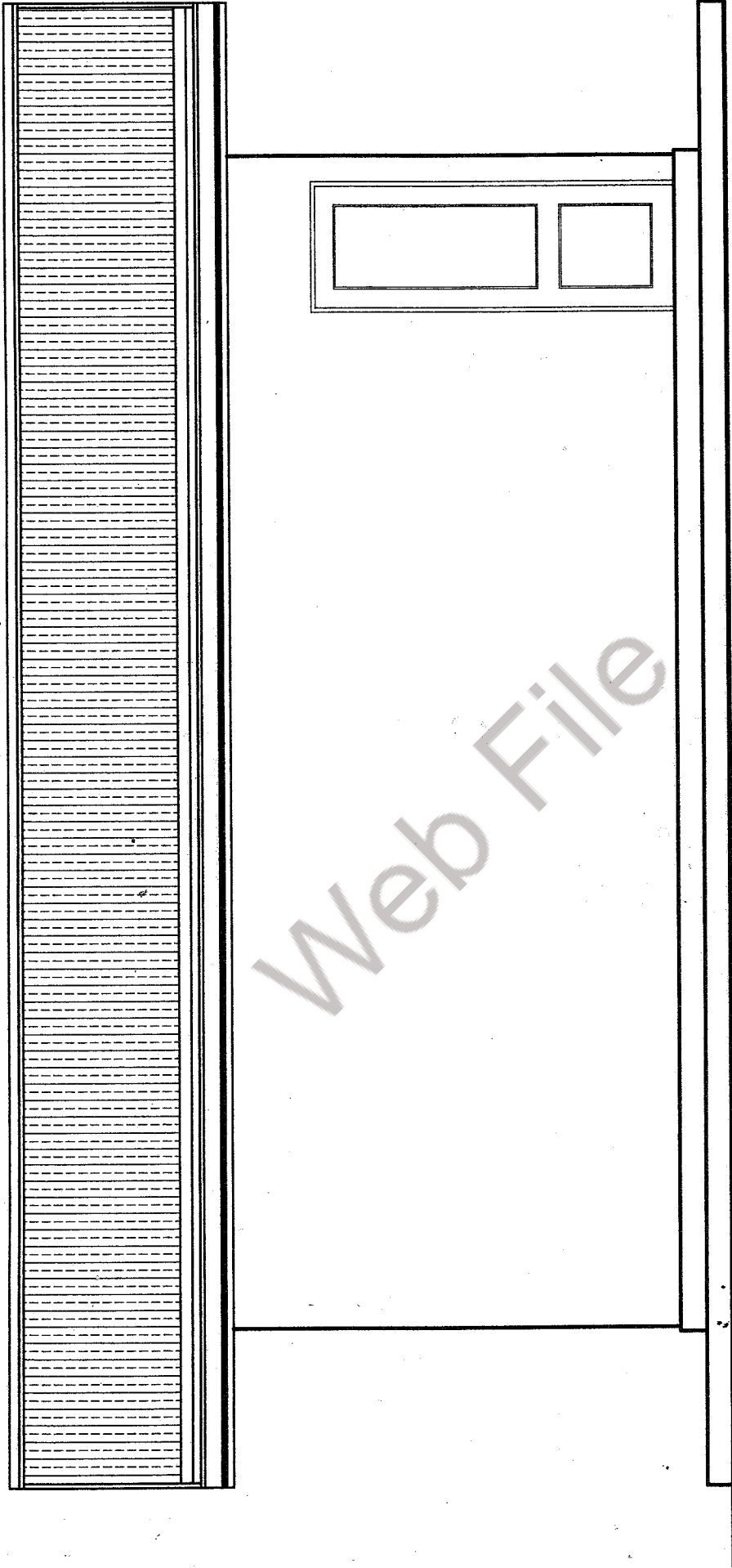

FRONT ELEVATION

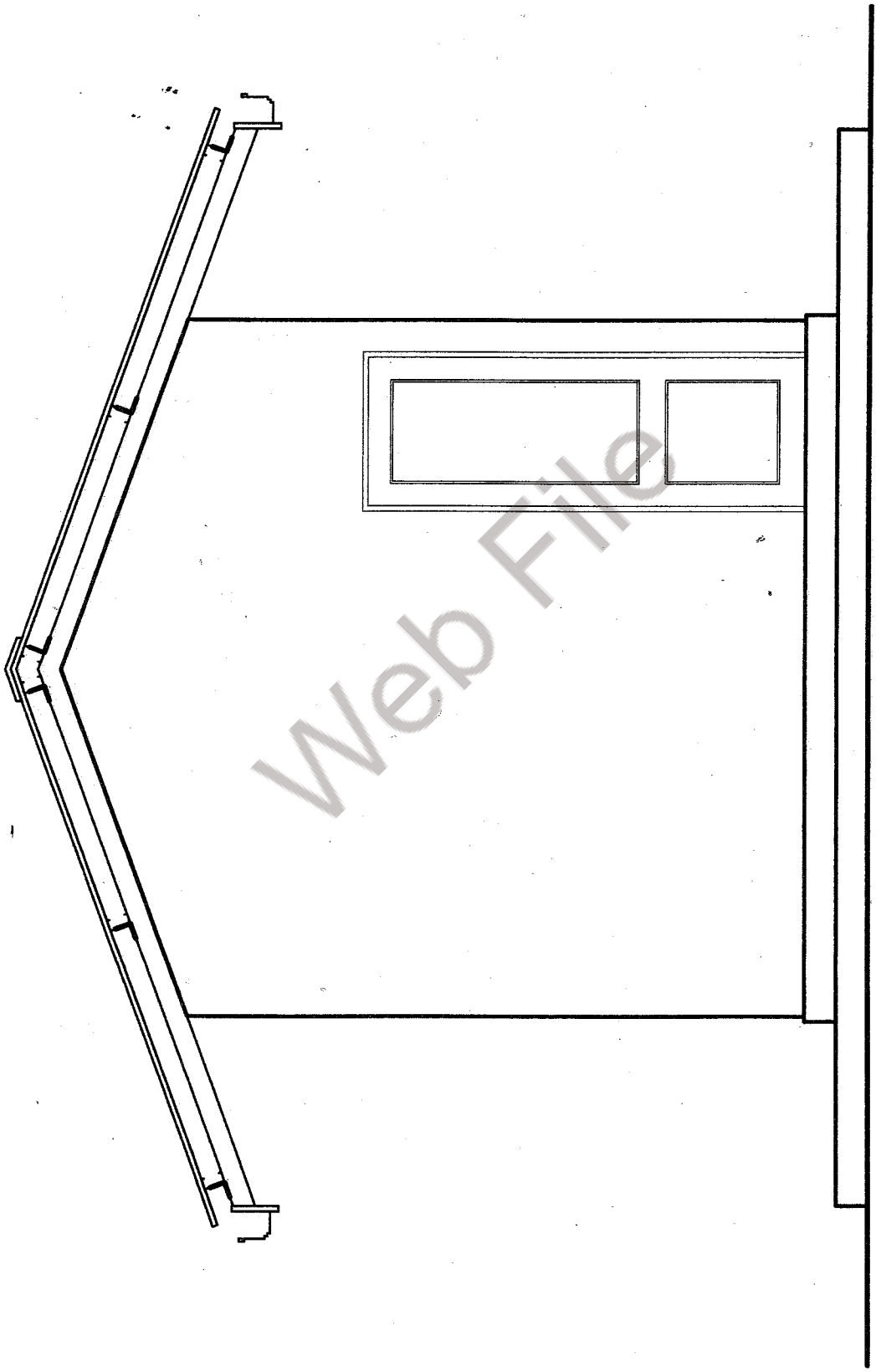

Web File

SIDE ELEVATION

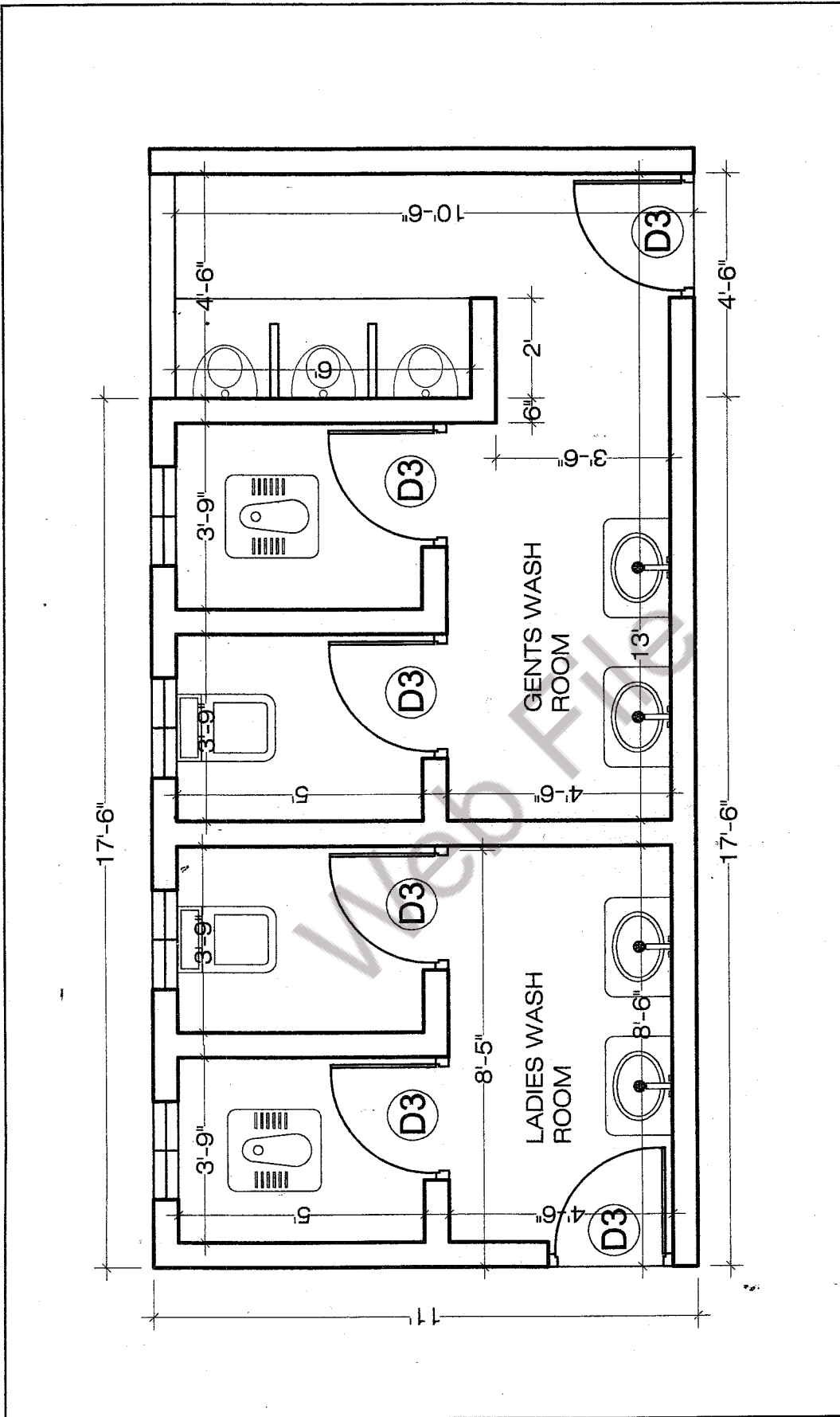

SANITARY BLOCK LAYOUT

0.

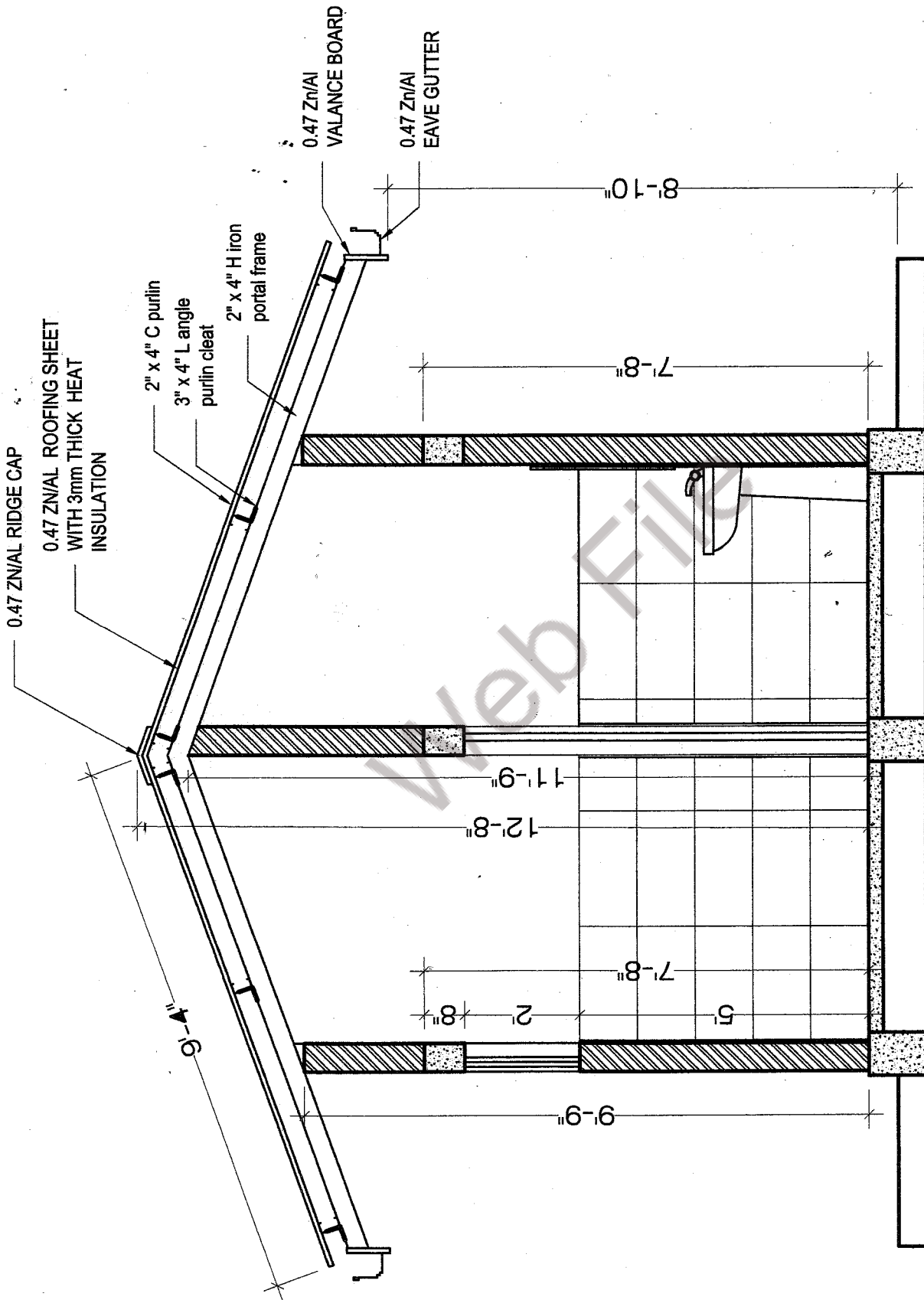

SECTIONAL ELEVATION

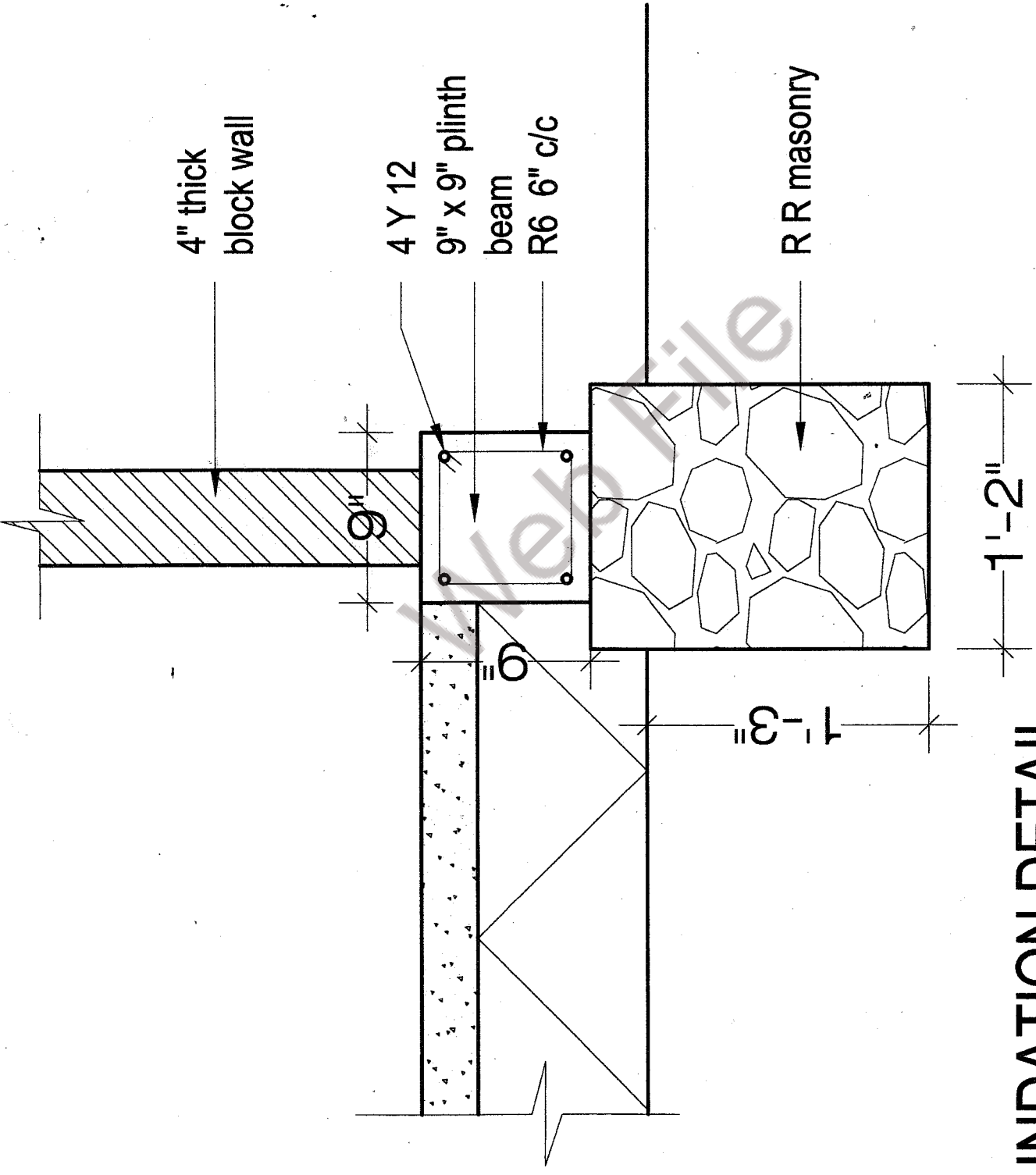

FOUNDATION DETAIL

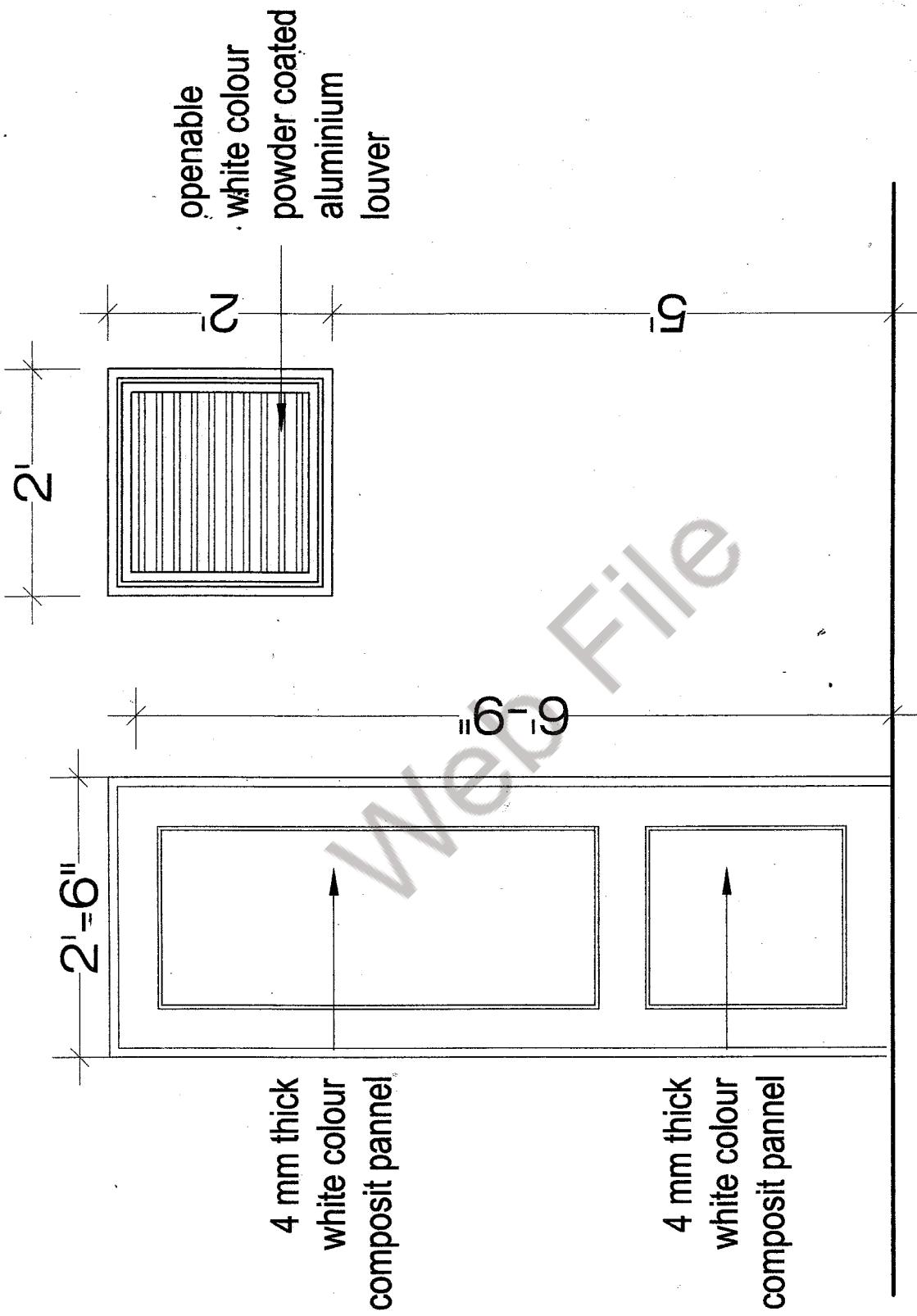

DOOR AND FAN LIGHT DETAIL

DRAINAGE SYSTEM LAYOUT

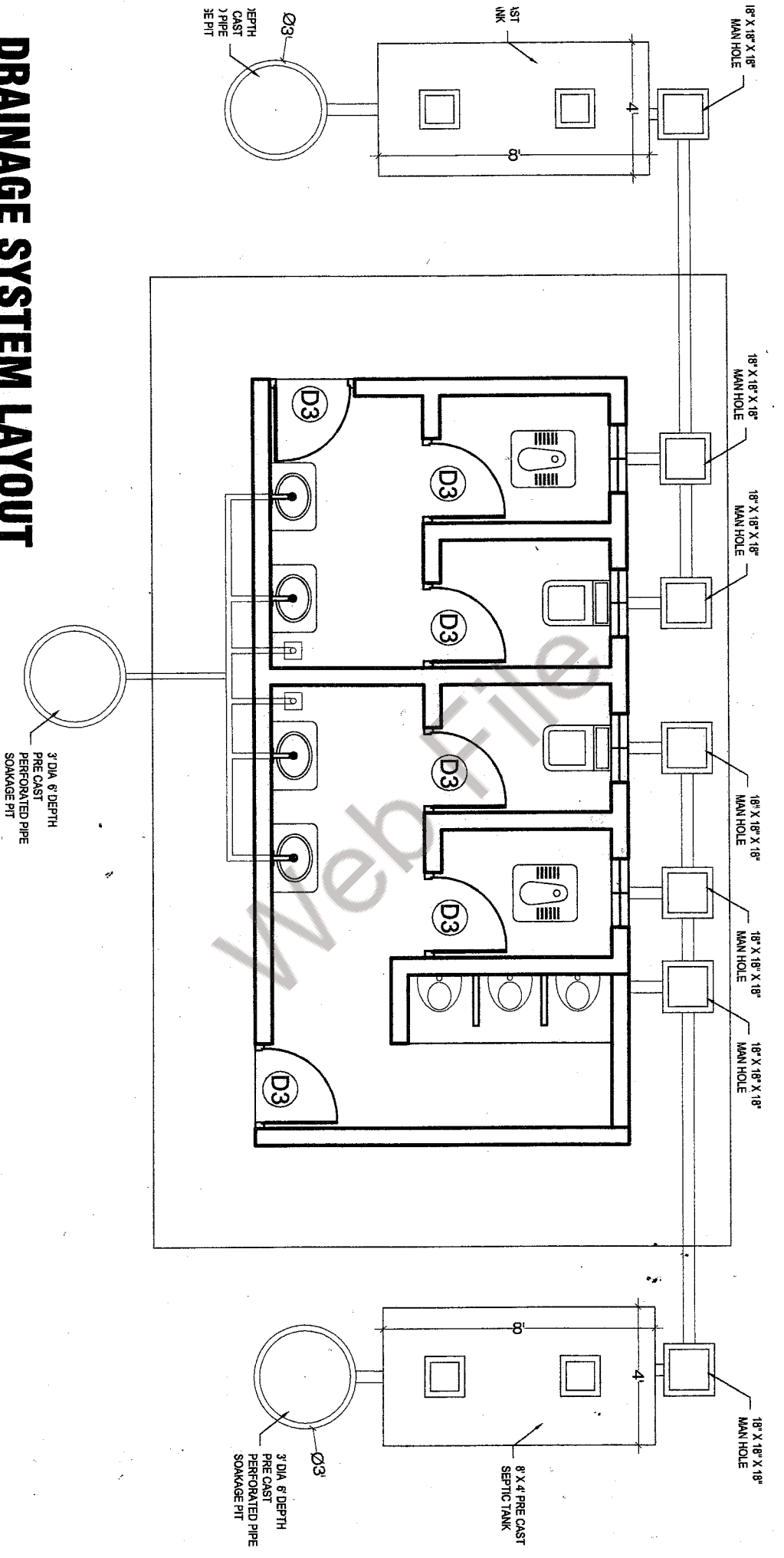

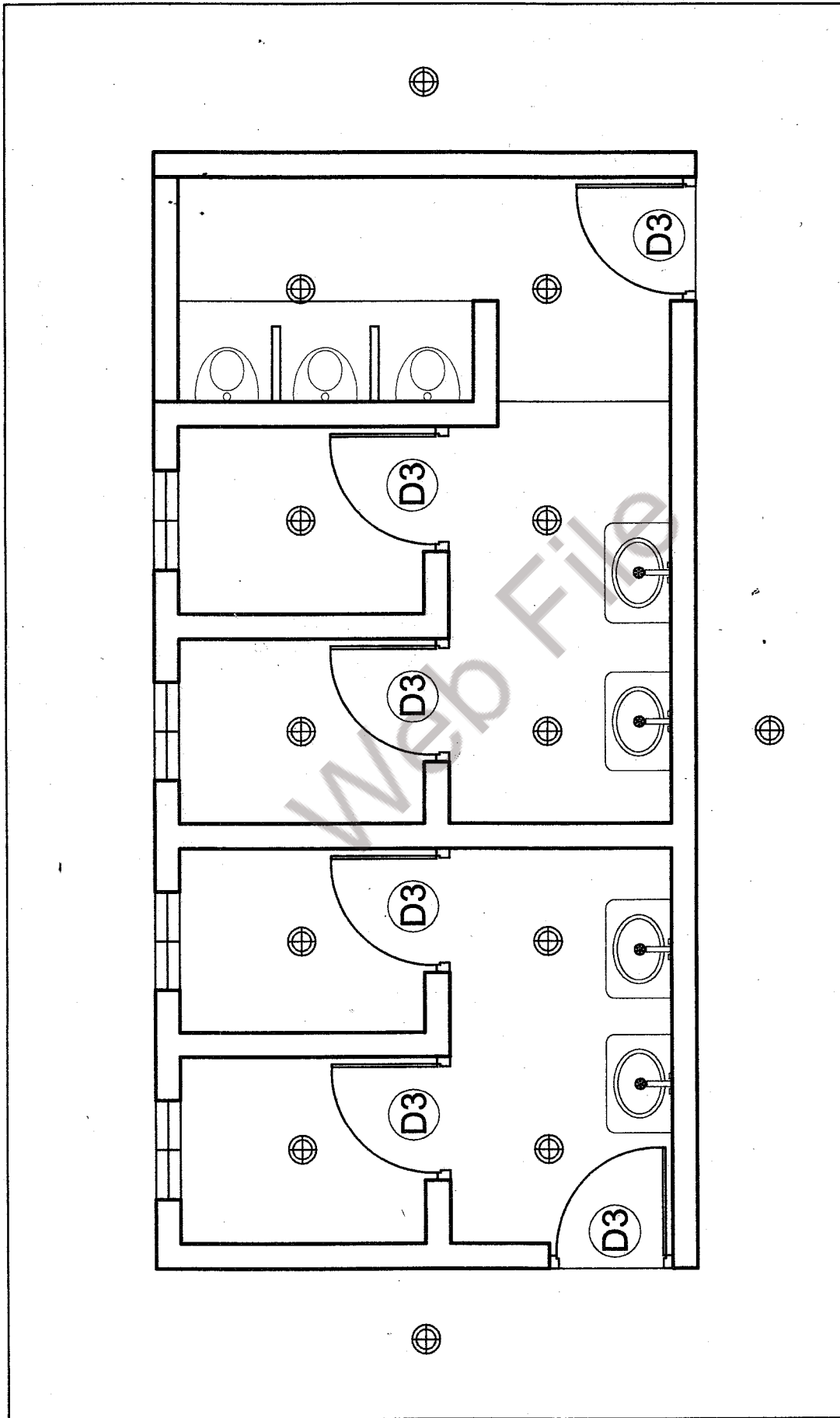

ELECTRICAL LAYOUT

Section 09

STANDARD FORMS (BID)

Bid Security

Notes on Standard Forms:

Bidders shall submit the completed Form of Bid Security as appropriate in compliance with the requirements of the bidding documents.

Bidders should not complete the Form of Agreement at the time of preparation of bids.

The successful bidder will be required to sign the Form of Agreement ,after the award of contract.

Any corrections or modifications to the accepted bid resulting from arithmetic corrections, acceptable deviations, or quantity variations in accordance with the requirements of the bidding documents should be incorporated into the Agreement.

The Form of Performance Security, Form of Advance Payment Security and Form of Retention Money Guarantee should not be completed by the bidders at the time of submission of bids.

The successful bidder will be required to provide these securities in compliance with the requirements herein or as acceptable to the Employer.



FORM OF BID SECURITY

[this Guarantee form shall be filled in accordance with the instructions indicated in brackets]
----- [insert issuing agency's name, and address of issuing branch or office]

Beneficiary: -----
[insert (by PE) name and address of Employer]

Date: ----- [insert (by issuing agency) date]

BID GUARANTEE No.: ----- [insert (by issuing agency) number]

We have been informed that ----- [insert (by issuing agency) name of the bidder] (hereinafter called "the bidder") has submitted to you its bid dated ----- [insert (by issuing agency) date] (hereinafter called "the Bid") for the execution of ----- [insert name of Contract] under Invitation for Bids No. ----- [insert IFB number] ("the IFB").

Furthermore, we understand that, according to your conditions, Bids must be supported by a Bid Guarantee.

At the request of the bidder, we ----- [insert name of issuing agency] hereby irrevocably undertake to pay you any sum or sums not exceeding in total an amount of ----- [insert amount in figures] ----- [insert amount in words] upon receipt by us of your first demand in writing accompanied by a written statement stating that the Bidder is in breach of its obligation(s) under the bid conditions, because the Bidder:

- (a) has withdrawn its Bid during the period of bid validity specified; or
- (b) does not accept the correction of errors in accordance with the Instructions to Bidders (hereinafter "the ITB"); or
- (c) having been notified of the acceptance of its Bid by the Employer during the period of bid validity, (i) fails or refuses to execute the Contract Form, if required, or (ii) fails or refuses to furnish the Performance Security, in accordance with the ITB.

This Guarantee shall expire: (a) if the bidder is the successful bidder, upon our receipt of copies of the Contract signed by the bidder and of the Performance Security issued to you by the bidder; or (b) if the bidder is not the successful bidder, upon the earlier of (i) the successful bidder furnishing the performance security, otherwise it will remain in force up to ----- (insert date)

Consequently, any demand for payment under this Guarantee must be received by us at the office on or before that date.

[signature(s) of authorized representative(s)]



FORM OF BID SECURING DECLARATION

*[If required, the Bidder shall fill in this form in accordance with the instructions indicated in brackets; * delete as appropriate]*

Name of contract -----

----- *[insert name by PE]*

Contract Identification N^o: -----

----- *[insert number by PE]*

Invitation for Bid No.: -----

----- *[insert number by PE]*

To: -----

----- *[insert the name of the Employer preferably PE to fill before issuing the bidding document]*

I/We, the undersigned, declare that:

1. I/We understand that, according to instructions to bidders (hereinafter "the ITB"), bids must be supported by a bid-securing declaration;
2. I/We* accept that we shall be suspended from being eligible for contract award in any contract where bids have being invited by any of the Procuring Entity as defined in the Procurement Guidelines published by National Procurement Agency of Sri Lanka, for the period of time of three years starting on the latest date set for closing of bids of this bid, if I/We:
 - (a) Withdraw our Bid during the period of bid validity period specified; or
 - (b) Do not accept the correction of errors in accordance with the Instructions to Bidders of the Bidding Documents; or
 - (c) having been notified of the acceptance of our Bid by you, during the period of bid validity, (i) fail or refuse to execute the Contract Form, if required, or (ii) fail or refuse to furnish the performance security, in accordance with the ITB.
3. I/We* understand this bid securing shall expire if we are not the successful bidder, upon the earlier of (i) the successful bidder furnishing the performance security; or (ii) twenty-eight days after the expiration of our bid.

Signed *[insert signature(s) of authorized representative]*

In the Capacity of *[insert title]*

Name *[insert printed or typed name]*

Dated on *[insert day]* day of *[insert month]*, *[insert year]*



Check list for Bidders

Bidders are advised fill the following table

Item	ITB clause	Yes (tick)	Reference
Form of Bid			
Addressed to the Employer?	18		
Completed?	18		
Signed?	18		
Bid securing Declaration form (If required)			
Properly filled and signed	16		
Bid securing (If required)			
Addressed to the Employer?	16		
Format as required?	16		
Issuing Agency as specified?	16		
Amount as requested?	16		
Validity 28 days beyond the validity of bid?	16		
Qualification information			
All relevant information completed?	4		
Signed?	4		
Addendum			
Contents of the Addendum (if any) taken into account?	10		
Bid package			
All the documents given in ITB Clause 12 enclosed in the original and copy?	19		
ITB Clause 19 followed before sealing the bid package?			

